

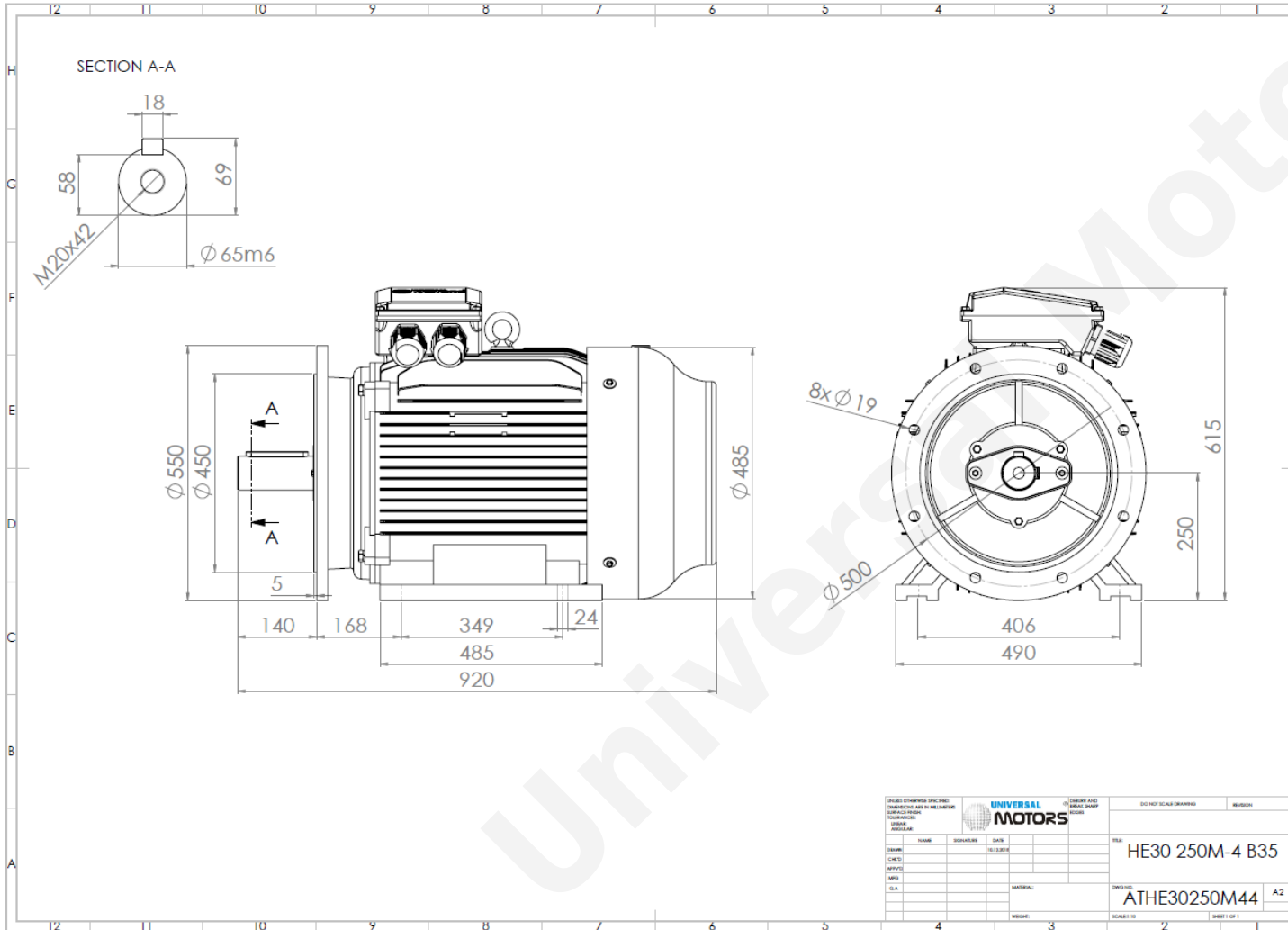

TECHNICAL DATA

Three Phase Electric Motors - Cast Iron Frame
 HE30 250 M-4 IE2
 55 kW / 75 Cv
 1480 RPM



Motor type:	HE30 250 M-4 IE2
Output:	55 kW / 75 Cv
Speed (min ⁻¹):	1480 RPM
Frequency:	50 Hz
Voltage:	400 V
Current:	99 A
Power factor (Cos Ø):	0.86
Poles:	4
Insulation class:	F
Temperature rise Class:	B
Efficiency 50%:	93.4 %
Efficiency 75%:	94.0 %
Efficiency 100%:	93.5 %
Torque:	355 N.m
Tstarting/Tnominal:	2.2
Istarting/Inominal:	7.6
Tmaximum/Tnominal:	2.3
Noise:	68 Db(A)
Weight:	420 Kg
Bearing DE:	6314 C3
Bearing NDE:	6314 C3

Regime - S1

Altitude - 1000m

Environment Temperature - 40°C

CONTACTS:

UNIVERSAL MOTORS Tel: +351 252 299 080
 Rua de São Brás,745 Fax: +351 252 299 089
 4480-782 VILA DO CONDE Mail: geral@universalmotors.pt

* References applied only in the UK